



# *BILLY GOAT<sup>®</sup> BC2402 Series Brush Cutter Owner's Manual*

*Patent Number D386768*



**ABOUT THIS MANUAL**

**THANK YOU** for purchasing a BILLY GOAT® *Brush Cutter*. Your new machine has been carefully designed and manufactured to provide years of reliable and productive service. This manual provides complete operating and maintenance instructions that will help to maintain your Brush Cutter in top running order. Read this manual carefully before assembling, operating or servicing your equipment.

**CONTENTS**

- Serial Plate Data ..... 3
- BC2402 Series Specifications ..... 3
- Common Replacement Parts ..... 3
- General Safety Instructions and Symbols ..... 4
- Sound Data ..... 6
- Vibration Data ..... 6
- Intended Use ..... 6
- Instruction Labels ..... 7
- Engine Labels ..... 7
- Assembly Instructions ..... 9
- Operation ..... 10
  - Operator Controls ..... 11
  - Starting ..... 11
  - Cutting ..... 13
  - Shut Down ..... 14
  - Cutting Height Adjustment ..... 14
  - Clearing a Clogged Cutting Deck ..... 14
- Handling and Transporting ..... 15
- Storage ..... 15
- Maintenance ..... 16
  - Periodic Maintenance ..... 16
  - Cleaning ..... 16
  - Blade Removal and Sharpening ..... 17
  - Blade Drive Belt Tension Adjustment ..... 18
  - Blade Clutch Adjustment ..... 19
  - Blade Drive Belt Removal and Replacement ..... 20
  - Transaxle Drive Clutch Adjustment ..... 22
  - Transaxle Drive Belt Removal and Replacement ..... 23
  - Wiring Diagrams ..... 21
- Troubleshooting ..... 25
- Engine Maintenance and Repair ..... 26
- Warranty Claim Procedure ..... 26
- Maintenance Record ..... 27
- Illustrated Parts List ..... 28

**Illustrations**

- Figure 1 Brush Cutter Assembly Drawing ..... 8
- Figure 2 Belt Routing Diagram ..... 21
- Figure 3 Starter Switch Wiring ..... 24
- Figure 4 Starter Circuit Schematic Diagram ..... 24
- Figure 5 ON/OFF Switch Circuit Schematic Diagram ..... 24
- Figure 6 Engine and Engine Base Assembly ..... 28
- Figure 7 Handlebar Assembly ..... 30
- Figure 8 Transaxle and Blade Deck Assembly ..... 32
- Figure 9 Blade Drive Spindle Assembly Detail Drawing ..... 34



**SERIAL PLATE DATA**

Record the model number, serial number, date of purchase, and where purchased.

Purchase Date: \_\_\_\_\_

Purchased From: \_\_\_\_\_

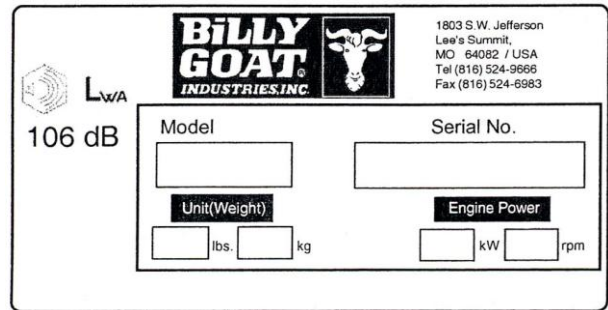

**BC 2402 SERIES SPECIFICATIONS**

	BC2402IC	BC2402H	BC2402HE	BC2402ICE
Engine Type	Briggs and Stratton INTEK OHV	Honda GXV	Honda GXV	Briggs and Stratton INTEK OHV
Model Number	21A902-0149-E1	GXV390UTIDABG	GXV390K1DE33	21A907-0147-E1
Horsepower	13.0 (9.7 kW)	13.0 (9.7 kW)	13.0 (9.7 kW)	13.0 (9.7 kW)
Fuel Capacity	3.0 qt (2.80 L)	2.3 qt (2.18L)	2.3 qt (2.18L)	3.0 qt (2.8L)
Oil Capacity	1.5 qt (1.4L)	1.2 qt (1.13L)	1.2 qt (1.13L)	1.5 qt (1.4L)
Engine Weight	58.0 lb (26.3 kg)	70.5 lb (32.0 kg)	72.5 lb (32.9 kg)	60.0 lb (27.3 kg)
Unit Weight	266 lb (120.7 kg)	278 lb (126.4 kg)	291 lb (132.3 kg)	273 lb (124.1 kg)
In accordance with 2000/14/EEC standards	106 dB(a)	106 dB(a)	106 dB(a)	106 dB(a)
Sound at Operator's ear	93 dB(a)	93 dB(a)	93 dB(a)	93 dB(a)
Shipping Weight	315 lb (143.2 kg)	330 lb (150.0 kg)	340 lb (154.7 kg)	325 lb (147.7 kg)
Overall Length	82.5 in (2.09 m)			
Overall Width	32.0 in (0.81 m)			
Overall Height	43 in (1.09 m)			
Maximum Operating Slope	15°	20°	20°	15°

**COMMON REPLACEMENT PARTS**

- Blade. P/N 500210. Original equipment replacement blade.
- High Lift Blade. P/N 500102. Optional replacement blade.
- Traction Drive Belt. P/N 500119. Original equipment replacement drive belt.
- Blade Drive Belt. P/N 500237. Original equipment replacement drive belt.
- Skid, Right Hand. P/N 500291. Right side deck skid.
- Skid, Left Hand, P/N 500292. Left side deck skid.
- Throttle Control Assembly. P/N 500213. Throttle control assembly, including cable.

## GENERAL SAFETY INSTRUCTIONS and SYMBOLS

The safety symbols shown below are used throughout this manual. You should be thoroughly familiar with them before assembling, operating or servicing this equipment.



**WARNING:** This symbol indicates important information that will prevent injury to yourself or others.



This symbol indicates ear protection is recommended when operating this equipment.



This symbol indicates eye protection is recommended when operating this equipment.



This symbol indicates gloves should be worn when servicing this equipment.



This symbol indicates that this manual and the engine manufacturer's manual should be read carefully before assembling, operation or servicing this equipment.



**CAUTION:** This symbol indicates important information that will prevent damage to your BILLY GOAT<sup>®</sup> Brush Cutter.



This symbol indicates the engine oil level should be checked before operating this equipment.

Read and make sure you thoroughly understand the following safety precautions before assembling, operating or servicing this equipment:



**READ** this manual and the engine manufacturer's manual carefully before assembling, operating or servicing this equipment.



**EAR PROTECTION** is recommended when operating this equipment.



**EYE PROTECTION** is recommended when operating this equipment.





**WARNING:** **EXHAUST** from this product contains chemicals known to the State of California to cause cancer, birth defects or other reproductive harm.

**DO NOT** operate this equipment on any unimproved forested, brushy, or grass covered land unless a spark arrester is installed on the muffler as required by Section 4442 of the California Public Resources Code. The arrester must be maintained in good working order. Other states may have similar laws. Federal laws apply on federal lands.

**DO NOT** run engine in an enclosed area. Exhaust gases contain carbon monoxide, an odorless and possibly fatal poison.





**WARNING:**  **DO NOT** run this equipment indoors or in any poorly ventilated area. Refueling outdoors is recommended.

 **DO NOT** refuel this equipment while the engine is running. Allow engine to cool for at least two minutes before refueling.

 **DO NOT** store gasoline near an open flame.

 **DO NOT** remove gas cap while engine is running.

 **DO NOT** start or operate engine if strong odor of gasoline is present.

 **DO NOT** start or operate engine if gasoline is spilled. Move equipment away from spill until gasoline has completely evaporated.

 **DO NOT** smoke while filling the fuel tank.

 **DO NOT** check for spark with spark plug or spark plug wire removed. Use an approved spark tester.

 **DO NOT** operate engine without a muffler. Inspect muffler periodically and replace if necessary. If equipped with muffler deflector, inspect deflector periodically and replace if necessary.

 **DO NOT** operate engine with grass, leaves or other combustible material near the muffler.

 **DO NOT** touch muffler, cylinder or cooling fins when hot. Contact with hot surfaces may cause severe burns.

 **DO NOT** leave equipment unattended while in operation.

 **DO NOT** park equipment on a steep grade or slope.

 **DO NOT** operate equipment with bystanders in or near the work area.

 **DO NOT** start equipment with drive or blade clutch engaged.

 **DO NOT** operate equipment with guards removed.

 **DO NOT** operate equipment in areas containing rock, glass, string-like material, wire, rags, cans, metal or other non-organic material.

 **DO NOT** operate equipment on slopes greater than specified in Specifications section of this manual.

 **DO NOT** operate equipment near hot or burning debris or any toxic or explosive materials.

 **DO NOT** allow children to operate this equipment.

**ALWAYS** remove spark plug wire when servicing equipment to prevent accidental starting.

**ALWAYS** check fuel lines and fittings frequently for cracks or leaks. Replace if necessary.

**ALWAYS** keep hands and feet away from moving or rotating parts.

**ALWAYS** store fuel in approved safety containers.



## SOUND DATA



**L<sub>WA</sub>** SOUND LEVEL 93 Dba at Operator's position  
106 dB

Sound tests were conducted in accordance with 2000/14/EEC and were performed on 2/21/2002 under the conditions listed below.

### NOTE

Sound power level listed is the highest value for any model covered in this manual. Please refer to serial plate on the unit for the sound power level for your model.

General Conditions:	Sunny
Temperature:	80°F (25°C)
Wind Speed:	2.0 mph (3.2 kph)
Wind Direction:	South
Humidity:	63.5%
Barometric Pressure:	29.98" Hg (761mm Hg)

## VIBRATION DATA

VIBRATION LEVEL .5g (4.87 m/s<sup>2</sup>)

Vibration levels at the operator's handles were measured in the vertical, lateral and longitudinal directions using calibrated vibration test equipment. Tests were performed on 5/19/1995 under the conditions listed below.

General Conditions:	Sunny
Temperature:	89°F (31.7°C)
Wind Speed:	6.1 mph (9.9 kph)
Wind Direction:	West
Humidity:	49.7%
Barometric Pressure:	29.88" Hg (101.19 kPa)

## INTENDED USE

Your BILLY GOAT® *BC Self-Propelled Brush Cutter* is designed for cutting overgrown weeds, brush and other growth down to 3½" (8.9 cm) in height. It is **not a lawn mower** and does not provide the quality cut of a finish cut mower. It is designed for use in rural areas and should not be operated in tight or confined areas.





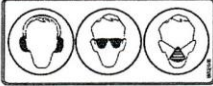
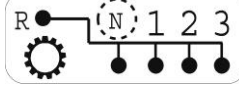

**INSTRUCTION LABELS**

The labels shown below were installed on your BILLY GOAT<sup>®</sup> Brush Cutter. If any labels are damaged or missing, replace them before operating this equipment. Item numbers from the Illustrated Parts List and part numbers are provided for convenience in ordering replacement labels. The correct position for each label may be determined by referring to the Figure and Item numbers shown.

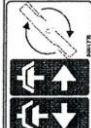
 <p>PN 400268 (See Figure 6 Item 169)</p>	 <p>PN 890254 (See Figure 6 Item 188)</p>	 <p>PN 500349 (See Figure 7 Item 186)</p>
--	--	--

 <p>Item No 180 - PN 400424 (See Figure 8 Item 180)</p>	 <p>Item No 184 - PN 810736 (See Figure 8 Item 184)</p>	 <p>Item No 187 - PN 890301 (See Figure 6 Item 187)</p>
--	--	--

 <p>PN 900327 (See Figure 6 Item 185)</p>	 <p>Item No 192 - PN 500177 (See Figure 7 Item 192)</p>	 <p>Item No 191 - PN 500176 (See Figure 7 Item 191)</p>
---	---	---

 <p>Item No 189 - PN 500168 (See Figure 6 Item 189)</p>	 <p>PN 500279 (See Figure 6 Item 190)</p>
--	---

**ENGINE LABELS**

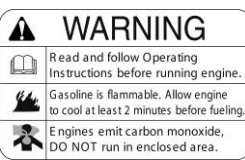
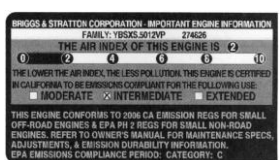
 <p>HONDA</p>	  <p>BRIGGS and STRATTON</p>
--	---

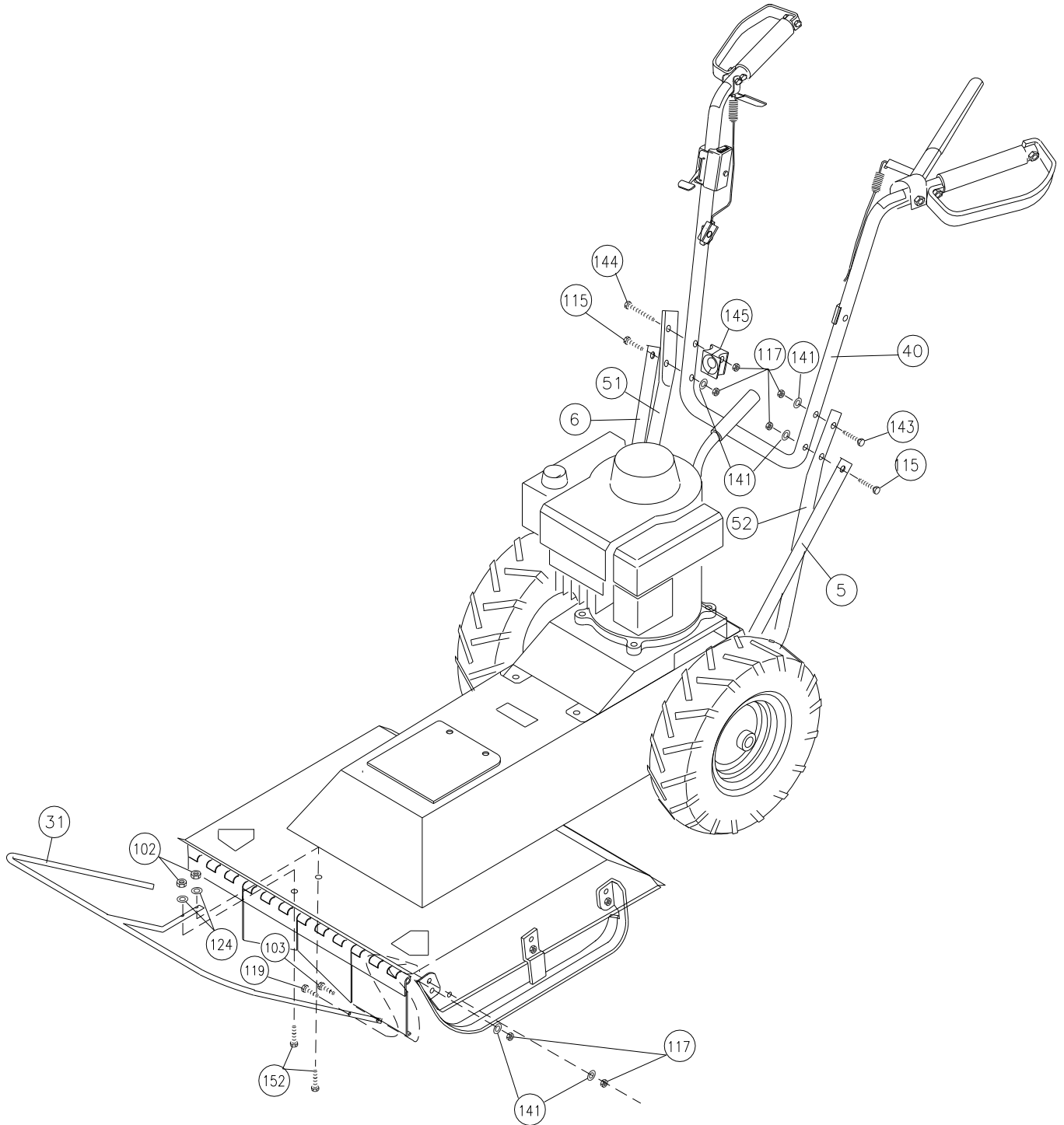

Brush Cutter Assembly Drawing  
Figure 1



## ASSEMBLY INSTRUCTIONS

Your BILLY GOAT<sup>®</sup> BC Self-Propelled Brush Cutter was shipped in one carton, completely assembled except for the upper handle assembly and the front guard bar. Mounting hardware for the handle and guard bar is temporarily installed on the lower handle and the front of the deck assembly.



**READ** all safety instructions before assembling unit.

### NOTE

Electric start units are shipped without a battery. A CB18, C50, SC50 or MCB50 series dry or wet battery with a 17.2 Ah rating is required.

### NOTE

Numbers in parenthesis ( ) refer to item numbers on Figure 1 on the facing page.

1. Remove unit from carton. Make sure the following items that have been packed with unit:

- Upper Handle Assembly, P/N 500256
- Guard Bar, P/N 500235
- Owner's Manual, P/N 500264
- Honda or Briggs and Stratton Engine Manual
- Warranty Card, P/N 400972
- Ty-Wraps (4 ea)



**WARNING: DISCONNECT** spark plug wire before assembling unit.

2. Remove mounting hardware (144, 143, 115, 117, 141) from lower handles (51 and 52).
3. Loosen (but do not remove) four screws (115) securing the lower handles (51 and 52).
4. Attach upper handle (40) to lower handles (51 and 52) with hardware removed in step 2. Tighten finger tight only.
5. Make sure engine pull starter is properly installed in guide (145) and then tighten upper handle fasteners (Honda engine only).
6. Tighten mounting hardware on handle braces (5 and 6).
7. Remove mounting hardware (102, 103, 117, 119, 124 and 141) from deck and skid assembly.
8. Attach guard bar (31) to deck. Install center bolts (152) first and then side bolts.
9. For electric start models secure the battery (not included) in the battery plate (164), hook one side of the strap into the hole then stretch the strap across the top of the battery and hook the opposite side into the opposing hole on the plate. Make sure the battery will not move then connect terminals.

### NOTE













Items 117, 119 and 141 secure both front skid attachment and sides of front guard bar. Make sure both are securely attached.

9. Reconnect spark plug wire.

**OPERATION**



**WARNING:**

-  **DO NOT** run engine in an enclosed area. Exhaust gases contain carbon monoxide, an odorless and possibly fatal poison.
-  **DO NOT** start or operate engine if strong odor of gasoline is present.
-  **DO NOT** start or operate engine if gasoline is spilled. Move equipment away from spill until gasoline has completely evaporated.
-  **DO NOT** operate engine without a muffler. Inspect muffler periodically and replace if necessary. If equipped with muffler deflector, inspect deflector periodically and replace if necessary.
-  **DO NOT** operate engine with grass, leaves or other combustible material near the muffler.
-  **DO NOT** touch muffler, cylinder or cooling fins while engine is running. Contact with hot surfaces may cause severe burns.
-  **DO NOT** operate equipment with bystanders in or near the work area.
-  **DO NOT** operate equipment with guards removed.
-  **DO NOT** operate equipment in areas containing rock, glass, string-like material, wire, rags, cans, metal or other non-organic material.
-  **DO NOT** operate equipment on slopes greater than specified in Specifications section of this manual.
-  **DO NOT** operate equipment near hot or burning debris or any toxic or explosive materials.
-  **DO NOT** allow children to operate this equipment.

**ALWAYS** keep hands and feet away from moving or rotating parts.

**ALWAYS** check before use, transportation, or storage to make sure the battery is secured and straps holding battery are in good condition. If the strap breaks it will allow the battery to shift and could cause a short damaging the equipment. (Electric start)

**ALWAYS** connect battery terminals to proper connection cables. (Electric Start)



**EAR PROTECTION** is recommended when operating this equipment.



**EYE PROTECTION** is recommended when operating this equipment.

## OPERATOR CONTROLS

The operator's station is at the rear of the machine between the handlebars. The operator should STAND in a position to allow both handlebars to be grasped firmly and which allows sufficient leverage to steer the machine. Operator's controls are shown below.

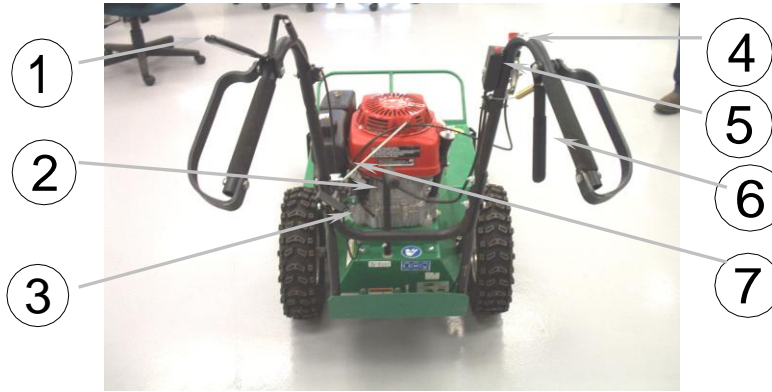

Operator Control Locations

- |   |                    |   |                    |
|---|--------------------|---|--------------------|
| 1 | Blade Clutch Lever | 5 | ON/OFF Switch      |
| 2 | Gear Shift Lever   | 6 | Drive Clutch Lever |
| 3 | Choke              | 7 | Pull Starter       |
| 4 | Throttle           |   |                    |

## STARTING



**CHECK** engine oil level before operating machine.

1. Place equipment on a level, firm surface that is free of rocks or other debris.
2. Place throttle in START position.



Throttle

3. Pull choke out (Honda engine only).

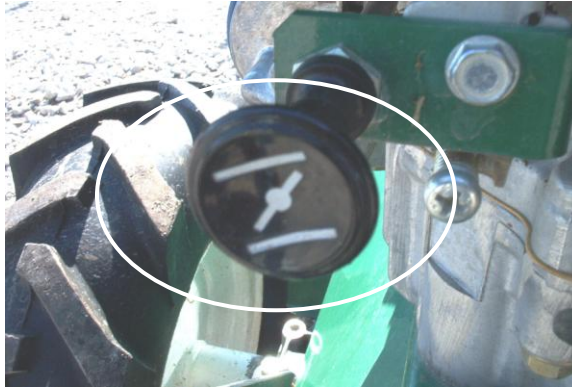

Choke

4. Units equipped with electric starters: Press and hold ON/OFF button until engine starts.



ON/OFF (I/O) Switch I-ON O-Off  
(Manual start shown)



**WARNING:** DO NOT START equipment with drive or blade clutch engaged.

5. Units equipped with manual starters: Pull starter rope to start engine.

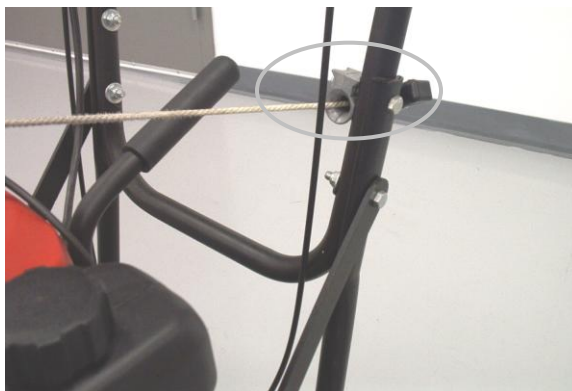



**WARNING:** **PULL STARTER CORD** slowly until resistance is felt. Then pull cord rapidly to avoid kickback.

6. Push choke in (Honda engine only).
7. Pull throttle control back to and allow engine to reach correct operating speed.

## CUTTING

The best performance is achieved when cutting in dry conditions. The quality of the cut is directly related to ground speed during cutting. Under most conditions cutting should be done in first or second gear. Third gear should be reserved for conditions where weeds and brush are thinned out or not very tall. If the quality of the cut is not satisfactory, shift into a lower gear.

1. Move shift lever to correct position (1, 2, 3 or Reverse) for desired gear.



Gear Shift Lever

2. Press blade clutch handle down to engage blade. Allow blade to spin up to normal operating speed.



Blade Clutch Lever

3. Pull drive clutch handle up to engage transaxle.



Drive Clutch Lever

## SHUT DOWN

1. Release drive clutch handle to disengage transaxle.
2. Release blade clutch handle to disengage blade.
3. Pull throttle control all the way back to the STOP position.
4. Place the ON/OFF (I/O) switch in the OFF (O) position.

## CUTTING HEIGHT ADJUSTMENT

Cutting height can be adjusted to allow a 1" (2.54 cm) lower cutting height. This is particularly useful for cutting grasses that tend to lay over when overgrown (i.e., Bermuda, Johnson, etc). When cutting brush and normal field grasses it is recommended that you operate the brush cutter at the standard (top) cutting height.

1. Shut engine off and wait for blade to stop completely.
2. Disconnect spark plug wire.
3. Remove bolts, nuts and washers (items 119, 103, 107, 141 and 117) from skid items (155, 156). To lower the cutting height, remount the skid with the hardware in lower holes on skid bracket. To raise the cutting height use the top holes on the skid. Repeat for the opposite side. Tighten the hardware securely.
4. Reconnect the spark plug wire.

## CLEARING A CLOGGED CUTTING DECK



**WARNING:**      **DISCONNECT** spark plug wire before servicing unit.

1. Shut engine off and wait for blade to stop completely.
2. Disconnect spark plug wire.
3. Remove clog from cutting deck.



**WEAR** durable gloves. Clog may contain sharp materials.

4. Reconnect spark plug wire.



## HANDLING and TRANSPORTING

Using four people to lift unit is recommended. Lift holding the handles and front deck guard. Make sure equipment is properly secured before transporting.





**WARNING:**  **NEVER** lift the machine while the engine is running.

## STORAGE



**WARNING:**  **DO NOT** store engine in an enclosed or poorly ventilated area where fuel fumes may reach an open flame or spark from a furnace, water heater, clothes dryer or similar devices.

 **DO NOT** drain fuel in an enclosed or poorly ventilated area.

 **DO NOT** smoke when draining fuel.

 **DO NOT** remove gas cap while engine is running.

 **DO NOT** park equipment on a steep grade or slope.

**ALWAYS** remove spark plug wire when servicing equipment to prevent accidental starting.

**ALWAYS** keep hands and feet away from moving or rotating parts.

**ALWAYS** store fuel in approved safety containers.

If the equipment will not be used for 30 days or more, prepare as follows:

1. Make sure engine is cool.
2. Drain gasoline from carburetor and fuel tank to prevent gum deposits from forming.
3. Run engine until tank is empty and engine runs out of gas.

### NOTE

Fuel stabilizer (such as Sta-Bil) is an acceptable alternative for minimizing the formation of gum deposits during storage. Add stabilizer to gasoline in storage container or fuel tank. Follow stabilizer manufacturer's instructions to determine proper mix ratio. Run engine at least 10 minutes after adding stabilizer to allow it to reach carburetor.





**MAINTENANCE**

**PERIODIC MAINTENANCE**

Periodic maintenance should be performed at the following intervals:

Maintenance Operation	Every Use	Daily or Every 5 Hours	Every 25 Hours	Every 50 Hours	Every 100-150 Hours
Inspect for worn or damaged parts.	•				
Check for excessive vibration		•			
Inspect for loose parts.		•			
Sharpen blade.			•		
Inspect belts for wear.			•		
Lubricate throttle control cable and linkage.			•		
Check blade clutch cable tension.				•	
Inspect battery for corrosion, damage or leaks (electric start units only).				•	
Apply anti-seize compound to rear axles.				•	
Check battery strap for excessive wear or rips	•				
Replace blade drive and transaxle drive belts.					•

**CLEANING**

Your BILLY GOAT® Brush Cutter should be cleaned periodically to ensure optimum performance and service life. Clogs and debris should be removed from the blade area and debris should be removed from the engine cooling fins. A garden hose or pressure washer may be used for cleaning.



**CAUTION:**  **DO NOT SPRAY WATER DIRECTLY ON THE BLADE CLUTCH WHEN USING A POWER WASHER. SEE FIGURE BELOW.**

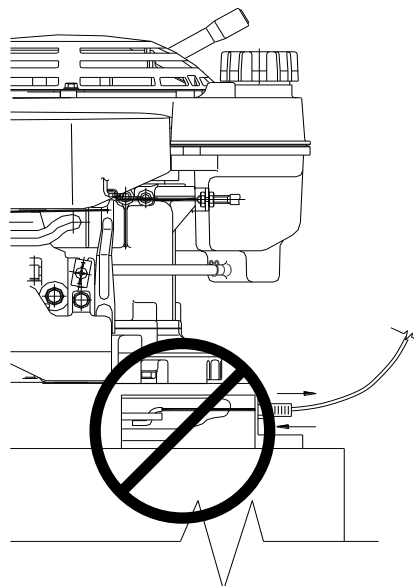

## BLADE REMOVAL AND SHARPENING



**READ** all safety instructions before servicing unit.

### NOTE

Numbers in parenthesis ( N-N ) refer to figure and item numbers in Illustrated Parts List.

Tools required:

- 5/8" socket, 1/2" drive
- torque wrench, 1/2" drive
- jack stands or similar device adequate to support weight of machine.



**WARNING:** **DISCONNECT** spark plug wire before servicing unit.

1. Disconnect spark plug wire.
2. Lift and support front of unit to allow access to underside.



**WARNING:** **UNIT IS HEAVY.** Make sure support is adequate to support weight of machine.

3. Block blade to prevent it from rotating during removal.
4. Remove blade bolt (8-139), lock washer (8-140) and friction washer (8-54).

### NOTE

Blade bolt (8-139) is a standard right-hand thread bolt.

5. Remove blade (8-50) and install replacement blade.

### NOTE

When replacing the blade use BILLY GOAT Industries PN 500210 only.

### NOTE

When sharpening blade make sure to sharpen all cutting edges.

6. Attach new blade with bolt (8-139), lock washer (8-140) and friction washer (8-54 removed earlier).

### NOTE

Inspect fasteners for wear and replace if necessary.

7. Torque blade bolt to 50 +/-5 ft-lbs.
8. Reconnect spark plug wire.

**BLADE DRIVE BELT TENSION ADJUSTMENT**

**READ** all safety instructions before servicing unit.



**WARNING:** **DISCONNECT** spark plug wire before servicing unit.

**NOTE**

Numbers in parenthesis ( N-N ) refer to figure and item numbers in Illustrated Parts List.

1. Disconnect spark plug wire.
2. Remove two screws holding engine base door (6-7) and remove door.
3. Examine condition of belt and not position of idler assembly and amount of tension on belt.
4. Loosen, **but do not remove**, two nuts (6-116) on top on engine base.
5. Reset belt tension by reaching in through top of engine base with pry bar or long screwdriver and pushing idler pulley against belt to increase tension (see below).

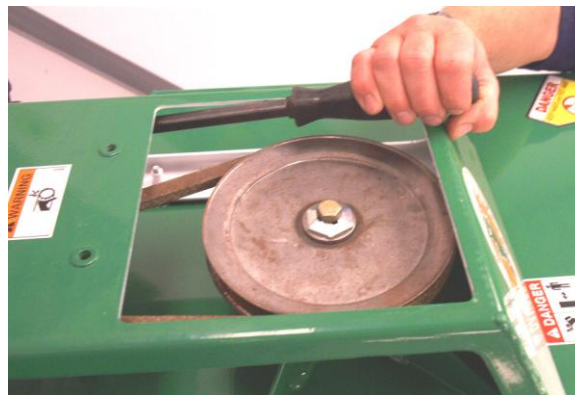

Adjusting Blade Drive Belt Tension

6. While holding belt under tension tighten two nuts (6-116) holding idler pulley in place.
7. Replace engine base door (6-7) and secure with screws removed earlier.
8. Reconnect spark plug wire.
9. Check belt tension by operating unit under conditions that caused belt slippage. If belt continues to slip it may require replacement before operation may continue.

## BLADE CLUTCH ADJUSTMENT



**READ** all safety instructions before servicing unit.



**WARNING:** **DISCONNECT** spark plug wire before servicing unit.

1. Disconnect spark plug wire.
2. As the clutch/brake wears or begins slipping or squealing, adjustment may be required to maintain proper cable tension and clutch engagement. A properly adjusted blade clutch should require 10 lbs of force to depress the end of the clutch lever. The blade clutch cable spring should stretch 1/4" to 3/8" (6.4-9.5 mm).
3. Adjust cable tension by tightening or loosening cable adjustment nut on rear of engine base (see below). Be sure to leave enough slack in cable to allow blade brake to engage.

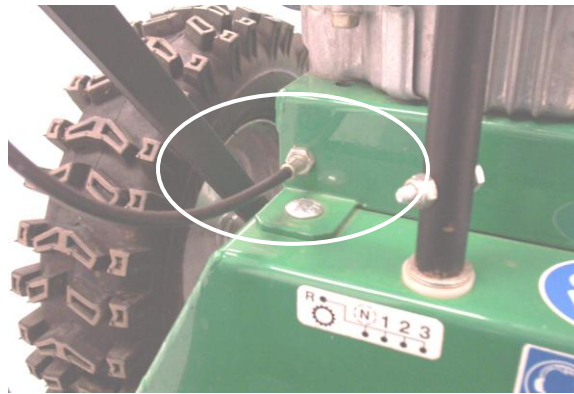

Blade Cable Adjustment



**CAUTION:** If clutch continues to slip or squeal, do not operate equipment until adequate adjustment or repair has been performed. Improper adjustment can cause clutch to overheat and slip, greatly reducing performance and clutch life.

4. Reconnect spark plug wire.



## BLADE DRIVE BELT REMOVAL AND REPLACEMENT



**READ** all safety instructions before servicing unit.

### NOTE

Numbers in parenthesis (N-N ) refer to figure and item numbers in Illustrated Parts List.

Tools required:

- 1/2" socket, 3/8" drive
- ratchet, 3/8"
- drive extension, 3/8" drive
- universal joint, 3/8" drive
- pry bar or long screwdriver
- jack stands or similar device adequate to support weight of machine.



**WARNING:** **DISCONNECT** spark plug wire before servicing unit.

1. Disconnect spark plug wire.
2. Lift and support rear of unit to allow access to underside.



**WARNING:** **UNIT IS HEAVY.** Make sure support is adequate to support weight of machine.

3. Remove two screws (6-103) and washers (6-141) holding engine base door (6-7) and remove door.
4. Loosen, but **do not remove**, two nuts (6-116) holding idler mounting plate (6-26) to relieve tension on blade drive belt (8-29).

### NOTE

It may be necessary to pry idler pulley (8-9) away from its original position to release belt.

5. Using drive extension and universal joint, loosen, but **do not remove**, four screws (6-107) holding belt guides (6-149, 6-150) in place next to crankshaft drive pulley (8-9) at rear of machine.

### NOTE

If extension and universal joint are not available, remove stop bolt (6-110) and nuts (6-116, 6-117) to allow idler arm to swing back and allow access to screws (6-107).

6. Pull transaxle drive belt (8-10) from groove on pulley (8-9).
7. Pull blade drive belt (8-29) from groove on pulley (8-9) and down past pulley.
8. Pull belt back through hole in top of engine base and remove it from machine.

### NOTE

It will take some force to walk the belt past the front portion of the pulley.

9. Install new blade drive belt (8-29) on groove in pulley (8-9). Push remaining length of belt back through engine base toward clutch/brake drive pulley.
10. Install transaxle drive belt (8-10) on groove in pulley (8-9).
11. Reach through from rear of machine and pull new belt through and install it in the groove on the clutch/brake drive pulley.



**CAUTION:** Make sure blade drive belt is properly seated in clutch/brake drive pulley (6-23) and is not resting in gap between clutch/brake drive pulley (6-23) and transaxle drive pulley (6-46)

12. Tighten four screws (6-103) to secure belt guides (6-149, 6-150).



**CAUTION:** Make sure belt is correctly routed. (See Figure 2).

13. Adjust blade drive belt tension by reaching in through top of engine base with pry bar or long screwdriver and pushing idler pulley against belt to increase tension (see below).



Adjusting Blade Drive Belt Tension

14. While holding belt under tension tighten two nuts (6-116) securing idler plate.

15. Check belt tension by applying force on side of belt opposite idler pulley. Belt should deflect 3/16"-1/4" (4.8-6.4 mm) with force applied perpendicular to belt.

16. Replace engine base door (6-7) and secure with screws (6-103) and washers (6-141).

17. Reconnect spark plug wire.

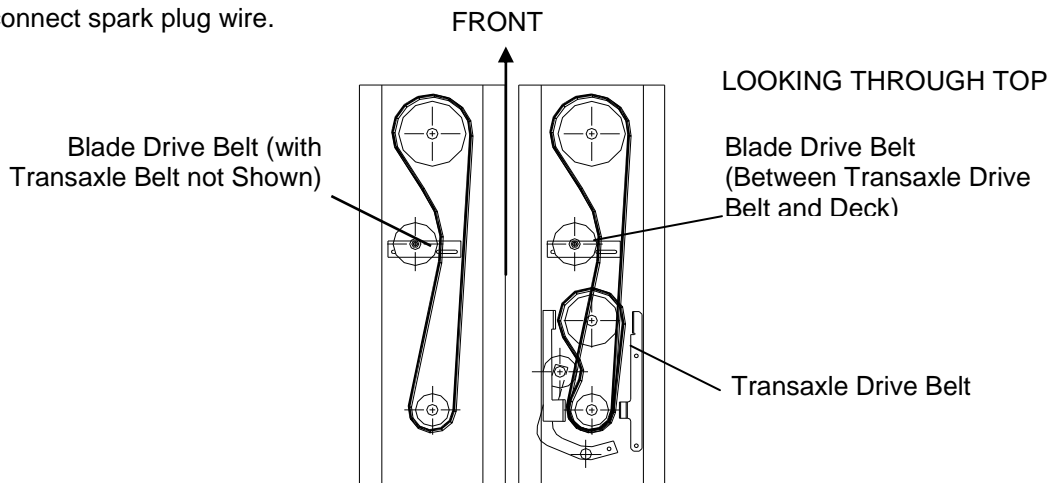

Belt Routing Diagram  
(Top View of Machine)  
Figure 2



## TRANSAXLE DRIVE CLUTCH ADJUSTMENT



**READ** all safety instructions before servicing unit.



**WARNING:** **DISCONNECT** spark plug wire before servicing unit.

1. Disconnect spark plug wire.
2. As the belt wears or begins slipping or squealing, adjustment may be required to maintain proper cable tension and clutch engagement. A properly adjusted transaxle drive clutch should require 3 lbs of force to depress the end of the clutch lever.
3. Adjust cable tension by tightening or loosening cable adjustment barrel on rear of engine base (see below).

**NOTE**

Moving the cable adjustment barrel **IN** decreases clutch tension. Moving the barrel **OUT** increases tension.

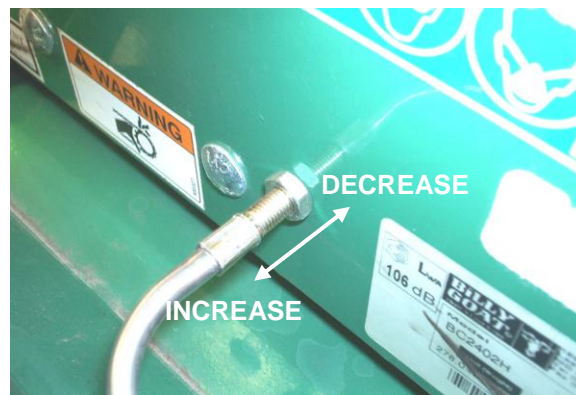

Transaxle Cable Adjustment

4. Reconnect spark plug wire.



## TRANSAXLE DRIVE BELT REMOVAL AND REPLACEMENT



**READ** all safety instructions before servicing unit.



Numbers in parenthesis ( N-N ) refer to figure and item numbers in Illustrated Parts List.

Tools required: 1/2" socket and ratchet, 1/2" universal extension bar, pry bar or long screwdriver, adequate support for machine.

- 1/2" socket, 3/8" drive
- ratchet, 3/8"
- drive extension, 3/8" drive
- universal joint, 3/8" drive
- pry bar or long screwdriver
- jack stands or similar device adequate to support weight of machine.



**WARNING:** **DISCONNECT** spark plug wire before servicing unit.

1. Disconnect spark plug wire.
2. Lift and support rear of unit to allow access to underside.



**WARNING:** **UNIT IS HEAVY.** Make sure support is adequate to support weight of machine.

3. Using drive extension and universal joint, loosen, but **do not remove**, four screws (6-107) holding belt guides (6-149, 6-150) in place next to crankshaft drive pulley (8-9) at rear of machine.



If extension and universal joint are not available, remove stop bolt (6-10) and nuts (6-116, 6-117) to allow idler arm to swing back and allow access to screws (6-107).

4. Pull belt (8-10) from groove on pulley (8-9) and down past pulley.
5. Slip belt (8-10) up and over pulley (8-9) and remove belt from machine.
6. Install new belt in grooves on pulley (6-46) and transaxle drive pulley (8-9).
7. Tighten four screws (6-107) to secure belt guides (6-149, 6-150).
8. Engage clutch levers and make sure belt guides do not touch belts.
9. Reconnect spark plug wire.

**WIRING DIAGRAMS**

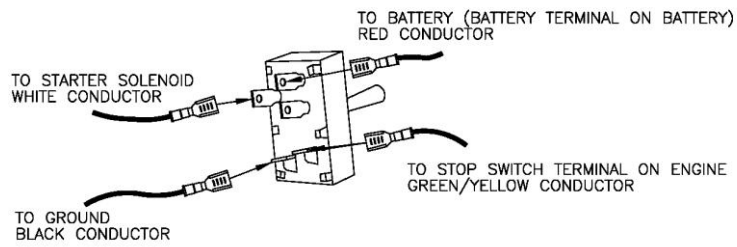

**Starter Switch Wiring  
Figure 3**

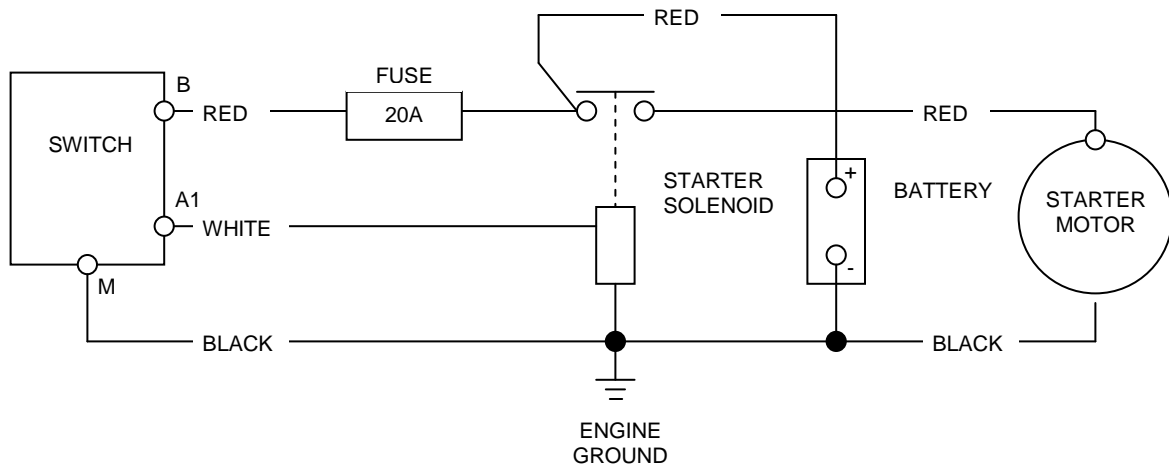

**Starter Circuit Schematic Diagram  
Figure 4**

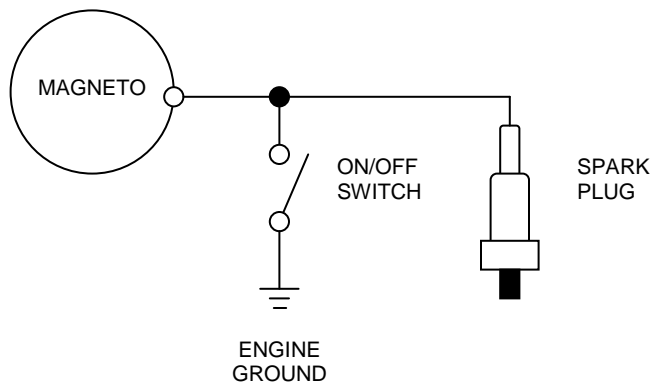

**ON/OFF Switch Circuit Schematic Diagram  
Figure 5**



**TROUBLESHOOTING**

Problem	Possible Cause	Corrective Action
Engine will not start.	ON/OFF switch is in OFF position.	Move switch to START position.
	Out of gasoline.	Fill gas tank.
	Old or contaminated gasoline.	Drain gas tank and fill with fresh gasoline.
	Spark plug wire disconnected.	Connect spark plug wire.
	Dirty air cleaner.	Clean or replace air cleaner.
Starter does not turn. (Electric start only)	Battery low or dead.	Charge or replace battery.
	Battery cable disconnected or corroded.	Clean and secure battery terminals.
	Defective starter switch or wiring harness.	Replace starter switch or wiring harness.
	Defective starter.	Replace starter.
Will not cut or cutting performance is poor.	Blade drive belt tension incorrect.	Adjust blade drive belt tension.
	Dull blade.	Sharpen or replace blade.
	Clogged deck.	Unclog deck.
	Excessive debris built up on or blocking blade.	Clear debris from blade area.
	Engine RPM set too low.	Check engine RPM.
Abnormal vibrations.	Blade loose or out of balance.	Check blade for tightness. Rebalance if necessary.
	Engine loose.	Check engine mounting bolts.
	Blade drive belt worn.	Replace blade drive belt.
Belt slips or smokes.	Belt tension too low.	Adjust belt tension.
	Belt worn or stretched.	Replace belt.
	Pulleys worn or damaged.	Replace pulleys.
Clutch slips or squeals.	Clutch cable tension too low.	Adjust clutch tension.
	Clutch worn or damaged.	Replace worn or defective clutch assembly parts.
Blade brake will not engage.	Inadequate slack in clutch cable.	Adjust clutch cable.
	Clutch worn or damaged.	Replace clutch/brake assembly.
Transaxle will not engage.	Clutch lever not engaging clutch.	Adjust clutch cable.
	Clutch cable defective.	Replace cable.
	Belt worn or broken.	Replace belt.
Transaxle will not disengage.	Clutch cable out of adjustment.	Adjust clutch cable.
Engine will not turn over.	Defective blade clutch.	Replace clutch.
	Engine problem.	Contact an authorized servicing dealer for your engine.



## **ENGINE MAINTENANCE AND REPAIR**

Refer to the engine manufacturer's manual for maintenance and service information. Warranty coverage on the engine is the responsibility of the engine manufacturer. If your engine requires warranty repair contact your local servicing engine dealer. Have your engine model number and serial number ready when you contact the dealer. If you cannot locate a servicing dealer in your area, you may contact the manufacturer's national service organization at the following numbers:

American Honda	(800) 426-7701
Briggs and Stratton	(800) 233-3723

## **WARRANTY CLAIM PROCEDURE**

Should a BILLY GOAT<sup>®</sup> machine fail due to a defect in material and/or workmanship, the owner should make a warranty claim as follows:

- The machine must be taken to the dealer from whom it was purchased or to an authorized Servicing BILLYGOAT Dealer.
- The owner must present the remaining half of the Warranty Registration Card, or, if this is not available, the invoice or receipt.
- The Warranty Claim will be completed by the authorized BILLY GOAT Dealer and submitted to their respective BILLY GOAT Distributor for their territory Attention: Service Manager. Any parts replaced under warranty must be tagged and retained for 90 days. The model number and serial number of the unit must be stated in the Warranty Claim.
- The distributor service manager will sign off on the claim and submit it to BILLY GOAT for consideration.
- The Technical Service Department at BILLY GOAT will study the claim and may request parts to be returned for examination. BILLY GOAT will notify their conclusions to the distributor service manager from whom the claim was received.
- The decision by the Service Department at BILLY GOAT to approve or reject a Warranty Claim is final and binding.



**ILLUSTRATED PARTS LIST**

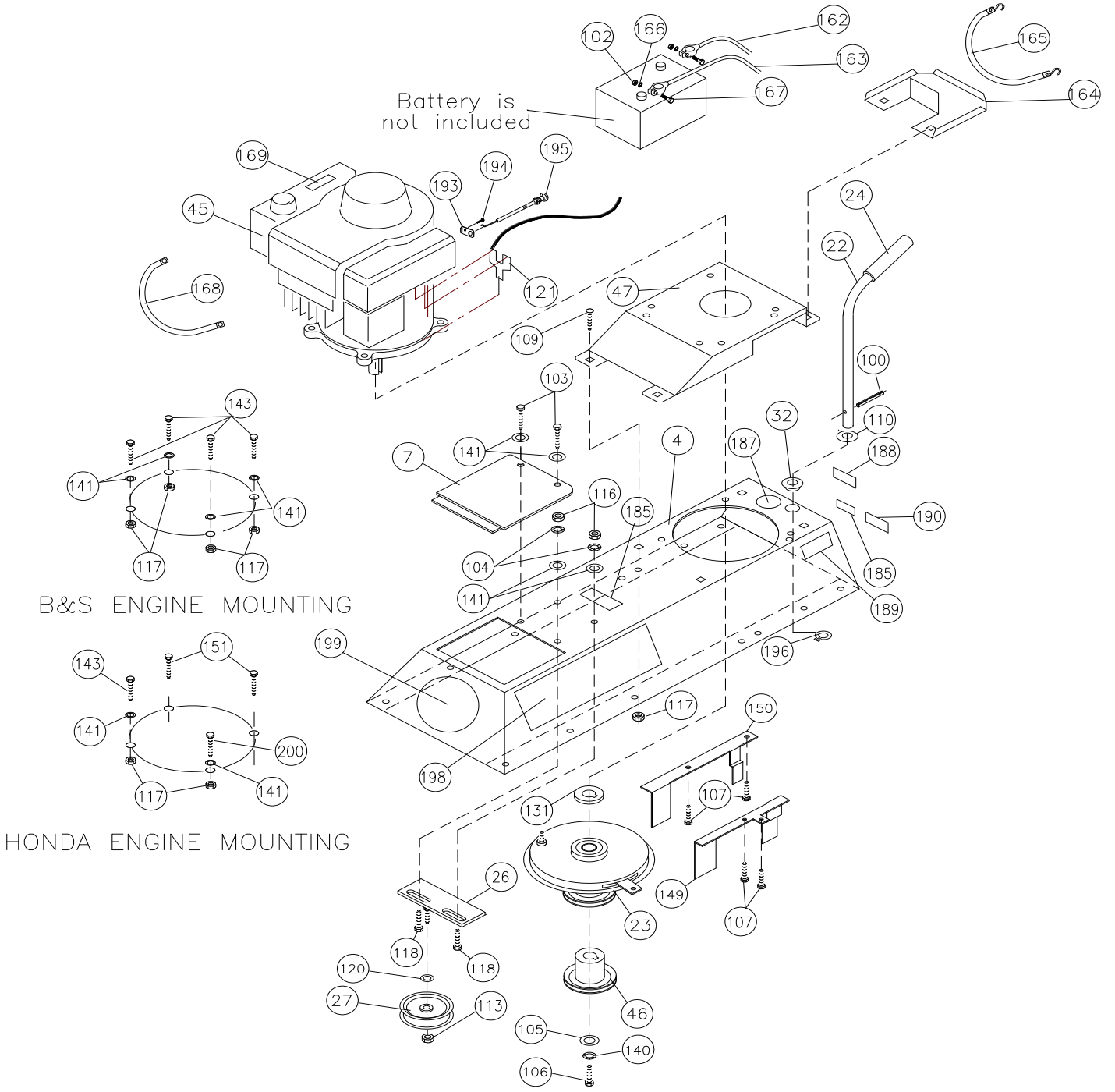



ITEM NO	DESCRIPTION	BC2402HE		BC2402H		BC2402ICE		BC2402IC	
		Part No	QTY	Part No	QTY	Part No	QTY	Part No	QTY
4	Base Assembly with labels	500240	1	500240	1	500240	1	500240	1
7	Door Base Engine	500233	1	500233	1	500233	1	500233	1
22	Tube Shift With Grip	500171	1	500171	1	500171	1	500171	1
23	Clutch Brake	500338	1	500338	1	500338	1	500338	1
24	Grip 3/4 ID - Black	610102	1	610102	1	610102	1	610102	1
26	Plate Mount Idler WA	500228	1	500228	1	500228	1	500228	1
27	Pulley Idler 4.5" OD X 3/8"	500270	1	500270	1	500270	1	500270	1
32	Bushing Shifter	500130	1	500130	1	500130	1	500130	1
45	13 HP Honda GXV390 Electric Start	500333	1	-	-	-	-	-	-
45	13 HP Honda GXV390	-	-	500334	1	-	-	-	-
45	13 HP OHV B & S	-	-	-	-	-	-	520046	1
45	13 HP OHV Briggs Electric Start	-	-	-	-	520039	1	-	-
46	Pulley Drive Traction BC	500238	1	500238	1	500238	1	500238	1
47	Spacer Engine WA 2401	500262	1	500262	1	500262	1	500262	1
100	Roll Pin 1/4 x 1 1/4	500351	1	500351	1	500351	1	500351	1
103	Screw Cap 5/16-18 x 1-1/4"	*8041029	2	*8041029	2	*8041029	2	*8041029	2
104	Washer Split Lock 5/16"	*8177011	2	*8177011	2	*8177011	2	*8177011	2
105	Plate Impeller Washer	850443	1	850443	1	850443	1	850443	1
106	Screw Cap 7/16-20 X 3"	500269	1	500269	1	500269	1	500269	1
109	Bolt Carriage 5/16-18 x 3/4 "	8024039	4	8024039	6	8024039	4	8024039	6
110	Washer Flat 1/2"	900230	2	900230	2	900230	2	900230	2
113	Nut Lock 3/8-16	*8160003	2	*8160003	2	*8160003	2	*8160003	2
116	Nut Jam 5/16-18	*8142002	2	*8142002	2	*8142002	2	*8142002	2
117	Nut Lock 5/16-18	*8160002	8	*8160002	8	*8160002	10	*8160002	10
118	Bolt Carriage 5/16-18 x 1"	*8024040	4	*8024040	2	*8024040	4	*8024040	2
120	Washer 3/8 FC	*8171004	1	*8171004	1	*8171004	1	*8171004	1
121	Terminal Piggyback 3/16	890010	1	890010	1	-	-	-	-
131	Spacer Engine	830113	1	830113	1	830113	1	830113	1
140	Washer Lock 7/16"	850132	1	850132	1	850132	1	850132	1
141	Washer 5/16" FC	*8171003	6	*8171003	6	*8171003	8	*8171003	8
143	Screw Cap 5/16-18 x 1-3/4"	*8041031	1	*8041031	2	*8041031	1	*8041031	4
149	Guide Belt LH	500230	1	500230	1	500230	1	500230	1
150	Guide Belt RH	500231	1	500231	1	500231	1	500231	1
151	Screw Cap 5/16-24 x 1"	*400164	2	*400164	2	-	-	-	-
162	Cable Battery Red W/Charge	500304	1	-	-	520111	-	-	-
163	Cable Battery Black 10"	790133	1	-	-	790133	1	-	-
164	Bracket Battery Rear	500347	1	-	-	500347	1	-	-
165	Strap Hold Down	790303	1	-	-	790303	1	-	-
166	Washer 1/4" SAE	8172007	2	8172007	2	8172007	2	8172007	2
167	Screw Cap 1/4-20 x 3/4"	8041004	2	8041004	2	8041004	2	8041004	2
168	Cable Battery Positive 8"	-	-	-	-	520123	1	-	-
169	Label Hot Engine	400268	1	400268	1	400268	1	400268	1
185	Label Guards	900327	2	900327	2	900327	2	900327	2
186									
187	Label Read	890301	1	890301	1	890301	1	890301	1
188	Label Ear Eye Breathe	890254	1	890254	1	890254	1	890254	1
189	Label Chock Wheels	500168	1	500168	1	500168	1	500168	1
190	Label Patent No	500279	1	500279	1	500279	1	500279	1
193	Plate Choke Mount BC	500325	1	500325	1	-	-	-	-
194	Screw Machine 10-32 x 3/4"	430248	1	430248	1	-	-	-	-
195	Control Cable Choke BC	500326	1	500326	1	-	-	-	-
196	Ring Retaining External 3/4"	520176	1	520176	1	520176	1	520176	1
198	Label Outback BC	500293	2	500293	2	500293	2	500293	2
199	Label Product Decal	890456	1	890456	1	890456	1	890456	1
200	Screwcap 5/16 -18 x 2	8041032	1			8041032	1		



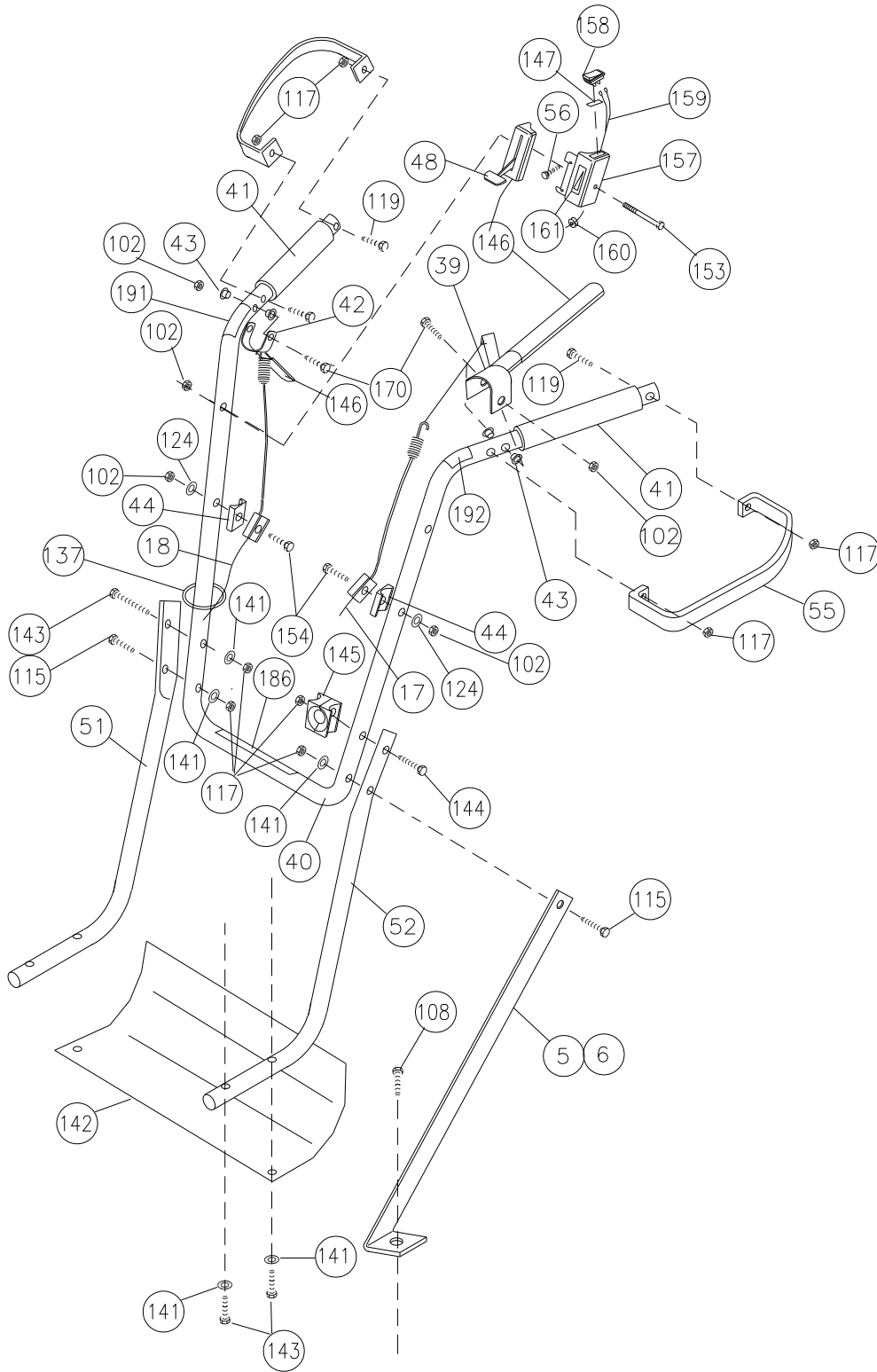

**Handlebar Assembly  
Figure 7**



ITEM NO	DESCRIPTION	BC2402HE		BC2402H		BC2402ICE		BC2402IC	
		Part No	QTY	Part No	QTY	Part No	QTY	Part No	QTY
5	Handle Brace Left	500196	1	500196	1	500196	1	500196	1
6	Handle Brace Right	500200	1	500200	1	500200	1	500200	1
17	Cable Clutch Blade BC2402	500259	1	500259	1	500259	1	500259	1
18	Cable Clutch Drive BC2402	500327	1	500327	1	500327	1	500327	1
39	Lever Control Blade	500312	1	500312	1	500312	1	500312	1
40	Handle Upper BC2402	500243-S	1	500243-S	1	500243-S	1	500243-S	1
41	Grip Handle 1" ID x 7.5"	500267	2	500267	2	500267	2	500267	2
42	Lever Control Clutch	500142	1	500142	1	500142	1	500142	1
43	Bushing Lever Control	500152	4	500152	4	500152	4	500152	4
44	Fitting Mount Cable	500187	2	500187	2	500187	2	500187	2
48	Throttle Control, Including Cable	500213	1	500213	1	500213	1	500213	1
51	Handle Lower RH BC2402	500140	1	500140	1	500140	1	500140	1
52	Handle Lower LH BC2402	500141	1	500141	1	500141	1	500141	1
55	Guard Hand BC2402	500339	2	500339	2	500339	2	500339	2
56	Screw Cap 8-3/8 HWH Type B	100121	2	100121	2	100121	2	100121	2
102	Nut Lock 1/4-20	*8160001	7	*8160001	7	*8160001	6	*8160001	6
108	Screw Cap 5/16-18 x 2-3/4"	*8041035	1	*8041035	1	*8041035	1	*8041035	1
115	Screw Cap 5/16-18 x 2"	*8041032	4	*8041032	2	*8041032	4	*8041032	2
117	Nut Lock 5/16-18	*8160002	10	*8160002	10	*8160002	10	*8160002	10
119	Screw Cap 5/16-18 x 1-1/2"	*8041030	4	*8041030	4	*8041030	4	*8041030	4
124	Washer 1/4" FC	*8171002	2	*8171002	2	*8171002	2	*8171002	2
137	Ty Wrap	900407	4	900407	4	900407	4	900407	4
141	Washer 5/16" FC	*8171003	5	*8171003	5	*8171003	7	*8171003	7
142	Bracket Clutch Cable Guard	500321	1	500321	1	500321	1	500321	1
143	Screw Cap 5/16-18 x 1-3/4"	*8041031	4	*8041031	5	*8041031	6	*8041031	7
144	Screw Cap 5/16-18 x 2-1/2"	*8041034	1	*8041034	1	*8041034	1	*8041034	1
145	Guide Rope (Honda only)	830533	2	830533	2				
146	Grip Lever	500181	2	500181	2	500181	2	500181	2
147	Label Start/Stop Toggle	500329	1			500329	1		
153	Screw Cap 1/4-20 x 3"	*8041014	1	*8041014	1	*8041014	1	*8041014	1
154	Screw Cap 1/4-20 x 2"	*8041010	2	*8041010	2	*8041010	2	*8041010	2
157	Switch Box Assy BC (includes throttle cable)	500318	1	500283-S	1	500318	1	500283-S	1
158	Switch Toggle, ON/OFF	500307	1	500281	1	500307	1	500281	1
159	Harness Assy	500306	1	890442	1	520118	1	890442	1
160	Bushing Strain Relief	500282	1	500282	1	500282	1	500282	1
161	Label Throttle	810656	1	810656	1	810656	1	810656	1
170	Bolt Shoulder 5/16-18 x 1-1/2"	500340	2	500340	2	500340	2	500340	2
186	Label Shift BC2402	500349	1	500349	1	500349	1	500349	1
191	Label Clutch Drive	500176	1	500176	1	500176	1	500176	1
192	Label Clutch Blade	500177	1	500177	1	500177	1	500177	1

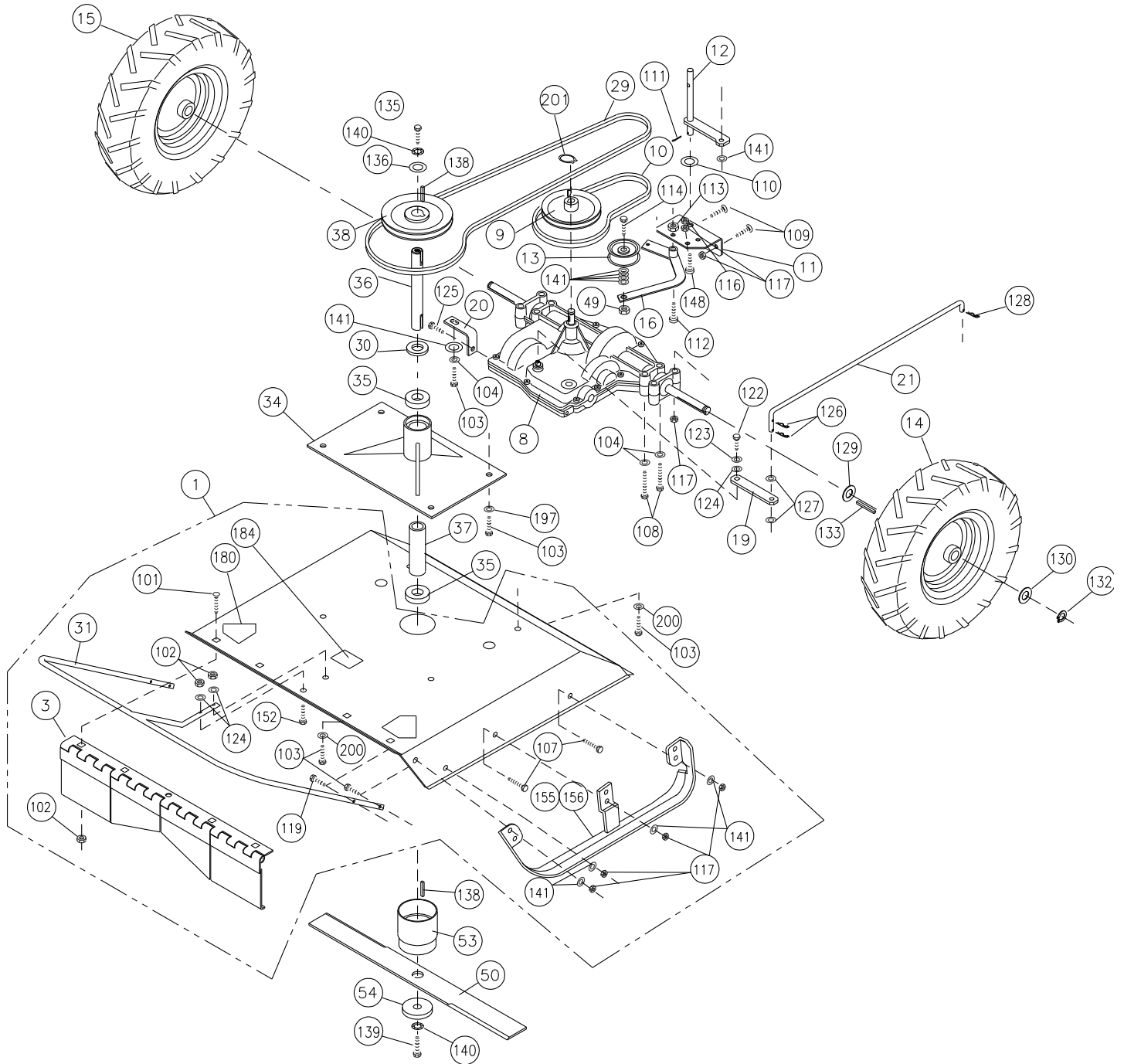

Transaxle and Blade Deck Assembly  
Figure 8



ITEM NO	DESCRIPTION	BC2402HE		BC2402H		BC2402ICE		BC2402IC	
		Part No	QTY	Part No	QTY	Part No	QTY	Part No	QTY
1	Deck Assembly with Labels	500239	1	500239	1	500239	1	500239	1
3	Deflector Front BC2402	500125	1	500125	1	500125	1	500125	1
8	Transaxle 3 SPD BC2402	500342	1	500342	1	500342	1	500342	1
9	Pulley 5.0" OD 'A' Section	830180	1	830180	1	830180	1	830180	1
10	Belt Traction Drive	500119	1	500119	1	500119	1	500119	1
11	Plate Pivot Idler/Shifter	500122	1	500122	1	500122	1	500122	1
12	Shifter Pivot WA	500169	1	500169	1	500169	1	500169	1
13	Pulley Idler	800260	1	800260	1	800260	1	800260	1
14	Wheel & Tire 16" SP LH	500343	1	500343	1	500343	1	500343	1
15	Wheel & Tire 16" SP RH	500344	1	500344	1	500344	1	500344	1
16	Arm Idler WA	500170	1	500170	1	500170	1	500170	1
19	Bar Shift T-axle	500121	1	500121	1	500121	1	500121	1
20	Angle Support T-axle	500127	1	500127	1	500127	1	500127	1
21	Rod Link Shifter	500144	1	500144	1	500144	1	500144	1
28									
29	Belt Blade Drive	500237	1	500237	1	500237	1	500237	1
30	Spacer Spindle BC2402	500232	1	500232	1	500232	1	500232	1
31	Bar Guard WA BC2402	500235	1	500235	1	500235	1	500235	1
33									
34	Spindle WA BC2402	500174	1	500174	1	500174	1	500174	1
35	Bearing 7/8" ID Sealed Press	500101	2	500101	2	500101	2	500101	2
36	Shaft Drive Blade	500107	1	500107	1	500107	1	500107	1
37	Spacer Spindle Bearing	500115	1	500115	1	500115	1	500115	1
38	Pulley 7" OD x 7/8" Bore	500253	1	500253	1	500253	1	500253	1
49	Nut Lock 3/8-16 Thin	8161042	1	8161042	1	8161042	1	8161042	1
50	Blade 24" BC2402	500210	1	500210	1	500210	1	500210	1
53	Adapter Blade WA	500191	1	500191	1	500191	1	500191	1
54	Washer Friction Blade	500108	1	500108	1	500108	1	500108	1
101	Bolt Carriage 1/4-20 x 3/4"	8024021	4	8024021	4	8024021	4	8024021	4
102	Nut Lock 1/4-20	*8160001	6	*8160001	6	*8160001	6	*8160001	6
103	Screw Cap 5/16-18 x 1-1/4"	*8041029	11	*8041029	11	*8041029	11	*8041029	11
104	Washer Split Lock 5/16"	*8177011	5	*8177011	5	*8177011	5	*8177011	5
107	Screw Cap 5/16-18 x 1"	*8041028	8	*8041028	8	*8041028	8	*8041028	8
108	Screw Cap 5/16-18 x 2-3/4 "	*8041035	4	*8041035	4	*8041035	4	*8041035	4
109	Bolt Carriage 5/16-18 x 3/4 "	8024039	4	8024039	4	8024039	4	8024039	4
111	Pin Cotter 3/32 x 3/4"	*8197016	1	*8197016	1	*8197016	1	*8197016	1
112	Bolt Shoulder 1/2 x 1"	500114	1	500114	1	500114	1	500114	1
113	Nut Lock 3/8-16	*8160003	1	*816003	1	*8160003	1	*8160003	1
114	Bolt Idler	800888	1	800888	1	800888	1	800888	1
116	Nut Jam 5/16-18	*8142002	1	*8142002	1	*8142002	1	*8142002	1
117	Nut Lock 5/16-18	*8160002	7	*8160002	7	*8160002	7	*8160002	7
119	Screw Cap 5/16-18 x 1-1/2"	*8041030	2	*8041030	2	*8041030	2	*8041030	2
122	Screw Cap 1/4-28 x 1/2" GR5	850408	1	850408	1	850408	1	850408	1
123	Washer Lock 5/16" External Tooth	8181008	1	8181008	1	8181008	1	8181008	1
124	Washer 1/4" FC	*8171002	3	*8171002	3	*8171002	3	*8171002	3
125	Screw Self Tap 5/16"	*8123128	1	*8123128	1	*8123128	1	*8123128	1
126	Pin Hair Cotter	900471	2	900471	2	900471	2	900471	2
128	Pin Cotter 3/32 x 3/4"	8197016	1	8197016	1	8197016	1	8197016	1
129	Washer 3/4" SAE	*8172015	2	*8172015	2	*8172015	2	*8172015	2
130	Washer 0.765 x 1.250 x 0.060"	850238	2	850238	2	850238	2	850238	2
132	Ring Snap 0.750"	850230	2	850230	2	850230	2	850230	2
133	Key 3/16 x 2-1/8"	9201087	2	9201087	2	9201087	2	9201087	2
135	Screw Cap 7/16-20 x 1-1/4" GR8	800554	1	800554	1	800554	1	800554	1
136	Washer 7/8 SAE	350153	1	350153	1	350153	1	350153	1
138	Key Sq 3/16 x 5/8"	9201072	2	9201072	2	9201072	2	9201072	2
139	Screw Cap 7/16-20 x 2" GR8	500188	1	500188	1	500188	1	500188	1
140	Washer Lock 7/16"	850132	2	850132	2	850132	2	850132	2
141	Washer 5/16 FC	*8171003	10	*8171003	10	*8171003	10	*8171003	10
152	Screw Cap 1/4-20 x 1-1/4"	*8041007	2	*8041007	2	*8041007	2	*8041007	2
155	Skid RH	500291	1	500291	1	500291	1	500291	1
156	Skid LH	500292	1	500292	1	500292	1	500292	1
180	Label OPEI	400424	2	400424	2	400424	2	400424	2
184	Label Flying Debris	810736	1	810736	1	810736	1	810736	1
197	Washer Lock 5/16 twisted tooth	800177	2	800177	2	800177	2	800177	2
200	Washer Lock 5/16 twisted tooth heavy	430298	4	430298	4	430298	4	430298	4
201	Snap ring	850233	1	850233	1	850233	1	850233	1

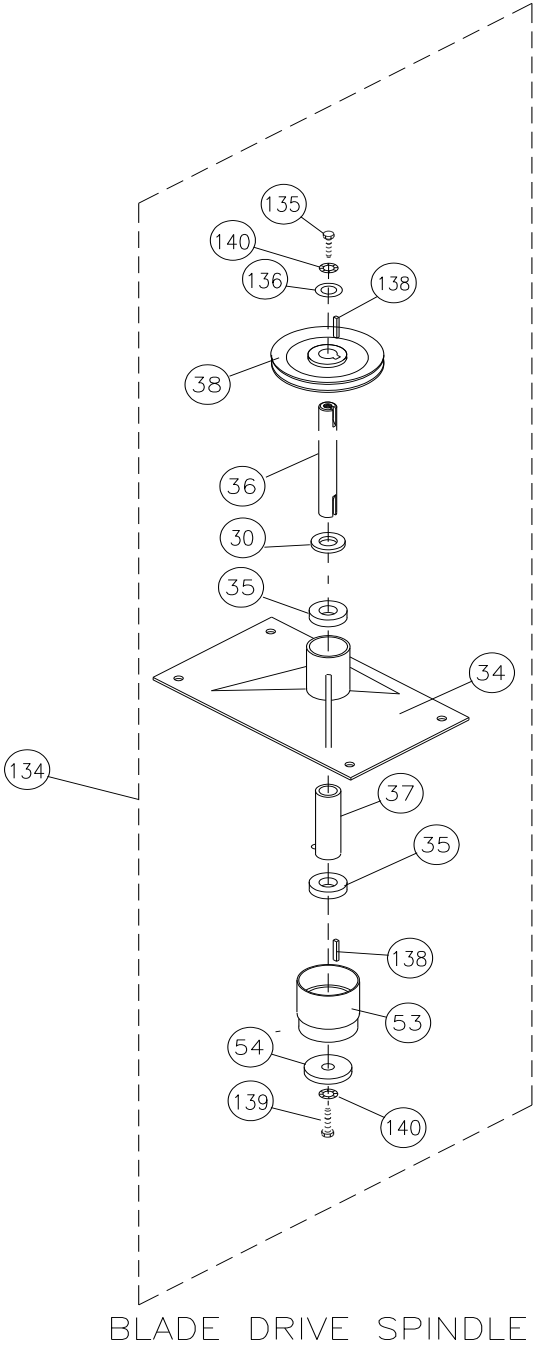

Blade Drive Spindle Assembly Detail Drawing  
Figure 9



ITEM NO	DESCRIPTION	BC2402HE		BC2402H		BC2402ICE		BC2402IC	
		Part No	QTY	Part No	QTY	Part No	QTY	Part No	QTY
134	Spindle Assembly Complete	500242	1	500242	1	500242	1	500242	1
30	Spacer Spindle BC2402	500232	1	500232	1	500232	1	500232	1
34	Spindle WA BC2402	500174	1	500174	1	500174	1	500174	1
35	Bearing 7/8" ID Sealed Press	500101	2	500101	2	500101	2	500101	2
36	Shaft Drive Blade	500107	1	500107	1	500107	1	500107	1
37	Spacer Spindle Bearing	500115	1	500115	1	500115	1	500115	1
38	Pulley 7" OD x 7/8" Bore	500253	1	500253	1	500253	1	500253	1
53	Adapter Blade WA	500191	1	500191	1	500191	1	500191	1
54	Washer Friction Blade	500108	1	500108	1	500108	1	500108	1
135	Screw Cap 7/16-20 x 1-1/4" GR8	800554	1	800554	1	800554	1	800554	1
136	Washer 7/8 SAE	350153	1	350153	1	350153	1	350153	1
138	Key Sq 3/16 x 5/8"	9201072	2	9201072	2	9201072	2	9201072	2
139	Screw Cap 7/16-20 x 2" GR8	500188	1	500188	1	500188	1	500188	1
140	Washer Lock 7/16"	850132	2	850132	2	850132	2	850132	2

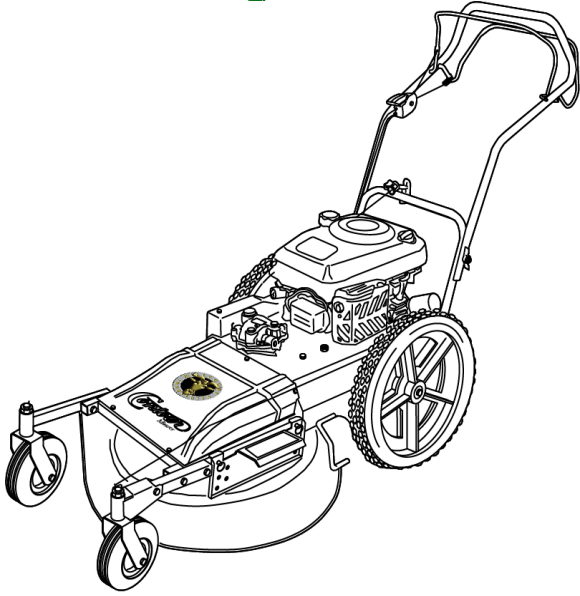

HIGH WHEEL MOWER

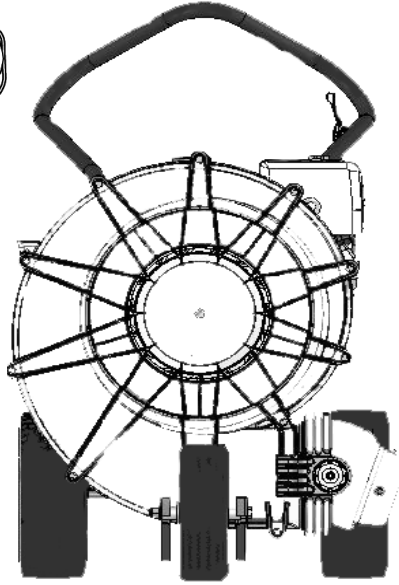

FORCE BLOWER

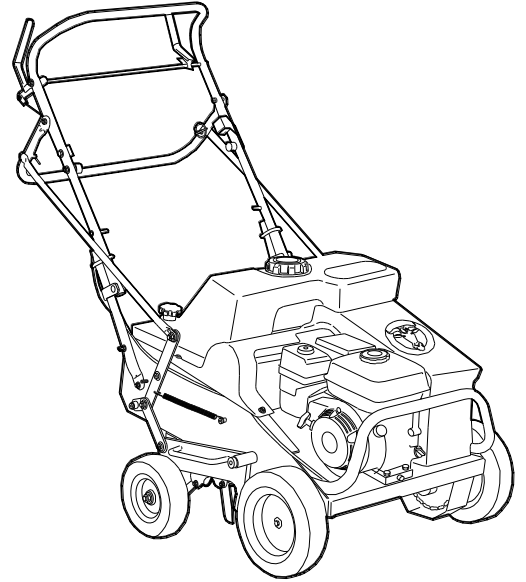

AERATOR

If you liked this product please feel free to view our full line of quality lawn care, renovation, and debris removal products at [www.billygoat.com](http://www.billygoat.com)

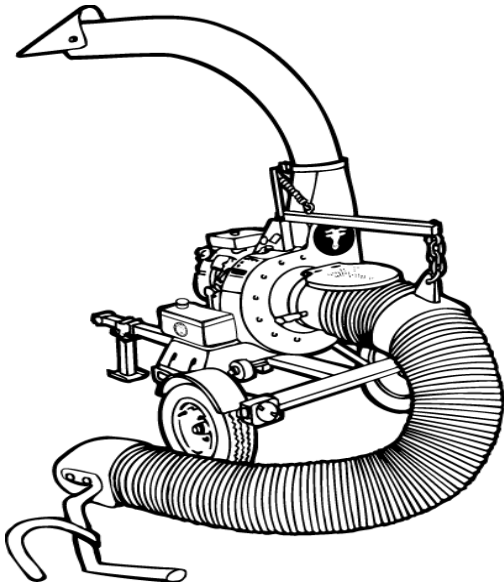

QL VACUUM

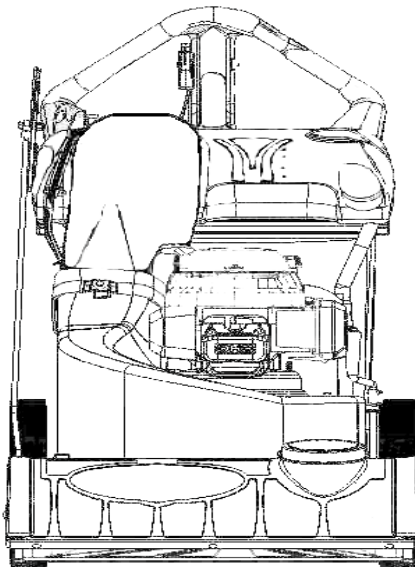

MULTI VACUUM

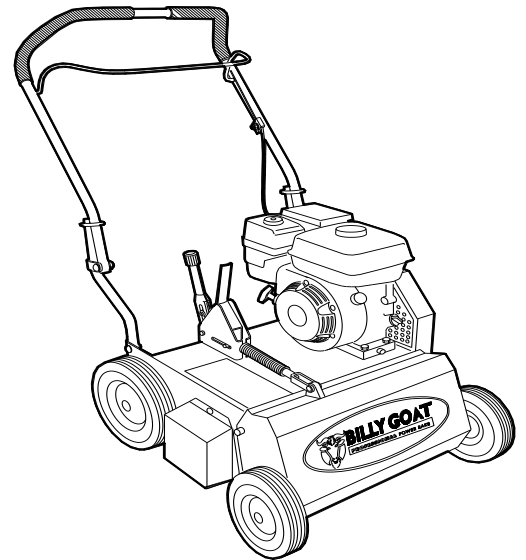

POWER RAKE

